



Enabling your Network for RCS Business Messaging

GSMA Future Networks

August 2019

Table of Contents

| | |
|---|-------------------------------------|
| Enabling your Network for RCS Business Messaging | 1 |
| Executive Summary | 1 |
| The demand for RCS Business Messaging | 2 |
| The Roles and Players in RBM | 2 |
| The A2P RBM Flow | 3 |
| The P2A RBM Flow | 4 |
| RBM Deployment Options..... | 6 |
| From on-premise to fully hosted | 6 |
| Every MNO has its own story..... | 7 |
| What the RCS/RBM vendors offer to MNOs | Error! Bookmark not defined. |
| RBM Platform Selection..... | 11 |
| Wider RCS Ecosystem | 12 |
| About the Authors | 13 |

Executive Summary

RCS Business Messaging is seeing the strongest momentum since its inception

Many MNOs are still in the process of evaluating RCS and the different ways of implementing it. This whitepaper looks to provide non-technical guidance for MNOs by showing the end-to-end ecosystem and RCS Business Messaging (RBM) message flows. This whitepaper will also report on the hands-on RCS and RBM experiences of Vodafone, Deutsche Telekom, Telefonica, KDDI, AT&T and China Mobile as they work towards a fully enabled network for RBM.

The main message expressed by all ecosystem players who contributed to this Whitepaper is get started with RCS Business Messaging as soon as possible. This whitepaper is a resource that can support this process.

Overview of RCS Business Messaging landscape

The demand for RCS Business Messaging (RBM)

In the current age of product commoditization enterprises are differentiating themselves more and more through providing superior customer experience. Messaging with SMS has proven its success as the channel of choice for personalized, timely and meaningful engagement between the enterprise brand and their Consumers.

RCS as an upgrade to A2P SMS Messaging and the features that it can provide give operators an opportunity to take more of the revenue share of digital marketing spend. These features mean that RCS can be used to replace app development and email campaigns by brands.

According to Statista, Digital Marketing budgets will grow at 10% CAGR to \$399bn by 2020. SMS Business Messaging growth has, however, slowed 3% CAGR (Compound Annual Growth Rate) to \$64bn. Conversely, MobileSquared forecasts RCS Business Messaging to grow from naught to \$12bn in only 4 years' time, with additional huge upside from search, advertising and customer care markets.

Live RCS brand campaigns have shown incredible uplifts in engagement rates and revenues compared to SMS campaigns. The GSMA website hosts a wide variety of videos and resources on these RCS show cases. Therefore, this whitepaper will not focus on the use cases but on how to make them come to life.

The Roles and Players in RBM

Identifying all the involved players and roles is key to a deeper understanding of RBM end to end. For more details, please refer to the GSMA [document](#) "WA.09 - RCS Ecosystem Principles".

To begin with, there are two main players: the enterprise brand and the individual mobile subscriber. The brand wants to send over some communication to its target recipients, the individual users with an RCS capable mobile device.

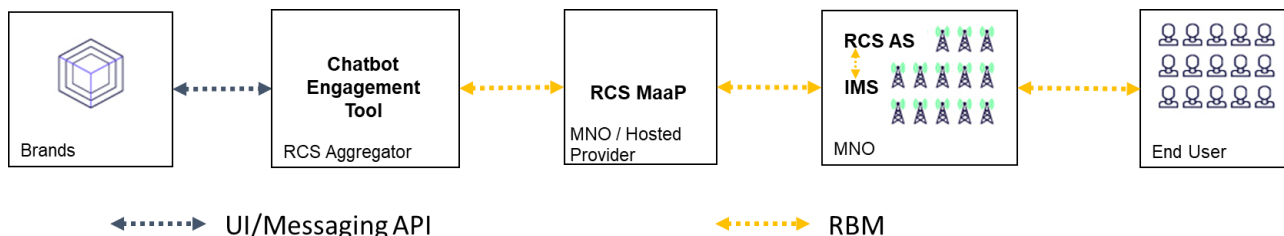

As you are aware the **Mobile Network Operator (MNO)** supplies the user with a SIM card and its associated connectivity contract. The MNO has a relationship with the user based on secure identity. As a result, SMS is more trusted by end users than any other app for business messages, a relationship RCS can adopt and build upon (MEF Mobile Fraud report 2017).

To enable RBM the MNO also has to enable its network for Person to Person (P2P) RCS. According to the RCS specifications this is achieved by enhancing the **IMS** network function with a designated RCS Application Server (AS) function. The IMS is like the general-purpose switch (think old fashioned operator connecting wires) but completely operated on IP basis using the so-called SIP protocol. The IMS can handle Voice over LTE (VoLTE) or Voice over WIFI, but with the help of the add-on called the **RCS AS** function, it can also manage RCS messages and RCS capabilities like sending a file from one RCS handset to another RCS device. We'll talk more about deployment options in the next chapter, but it is worth noting that vendors are offering as an option 'RCS in a box', which pretty much emulates an IMS with Application Servers – so you can also RCS enable your network holistically for P2P without having an IMS or touching your IMS.

Supporting P2P RCS is, however, not yet sufficient for transacting RCS business messages. For that the network needs another component, called **MaaP** (Messaging as a Platform). Distinguishing P2P from business messaging already on a protocol as well as network element level was one of the learnings from 25+ years of operating SMS, where the lack of separation of the two channels made the monetization of A2P SMS for the MNOs much harder. The MaaP instance gives the MNO full control over which chatbot with which ServiceID is allowed on its network. Think of the ServiceID not only as the identifier to the chatbot but also as the key to the look and feel of the chatbot: its sender name, its logo and colour scheme

As established in the SMS world, there are traffic aggregators whose job it is to connect and service many brands with their specific messaging needs, aggregate their traffic and send it to the right MNO. The **RCS Aggregator** removes the complexity for the MNO of handling hundreds of accounts, but it also abstracts the different networks from the brand. Additionally, the brand benefits from value added tools the aggregator is offering like higher level APIs or slick User Interfaces to create, manage and evaluate the mobile engagement. Concretely for RCS, we are talking about chatbot and campaign design tools. It might include artificial intelligence for Natural Language Processing and intent analysis that helps determine automatically the best response to a user.

We now have finally all the relevant roles to follow the flow of an RBM message from origin to destination. Of course, these are roles, which means that the MNO could also act as an RCS aggregator.

The A2P RBM Flow

Let's start with a simplified A2P scenario: The brand wants to send out e.g. a reminder message to the end user that he can pick-up the ordered purchase. We are starting from the moment the chatbot has received that trigger from the supply chain management system – i.e. the chatbot knows the content of the message as well as the target phone number (MSISDN).

First step is to find out which MNO the phone number belongs to. Figuring out the country is fairly straight forward based on the international prefix. But given that Mobile Number Portability (MNP) is supported in most countries a dedicated lookup is needed for determining the actual MNO, who has issued the SIM card associated to that MSISDN. Given that already today such MNP lookups are commonly used for routing SMS effectively, there are several vendors and solutions available. Next, the RCS Aggregator has a list of which MNO is served by which MaaP and its associated IP address – you could call this Routing to the correct MaaP.

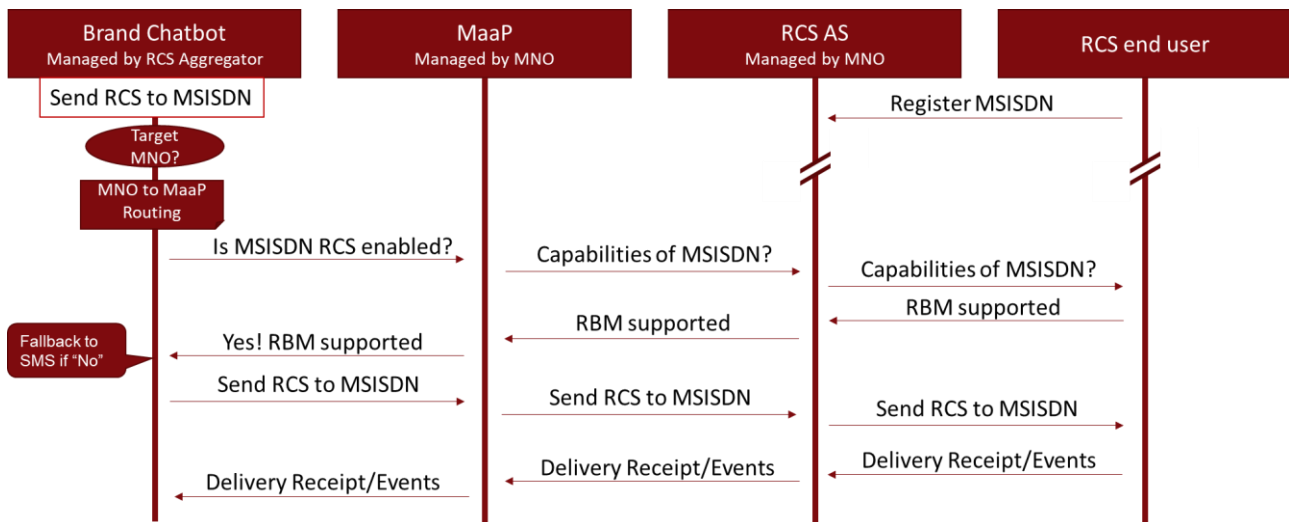

Now, the actual RCS communication can commence: Asking the MaaP about the RCS capability of the specific MSISDN (in order to determine if an SMS fallback is needed). After these enquiries, the RCS message can be submitted to the MaaP instance. The MaaP instance then hands the message over to the IMS with its RCS AS, which eventually delivers it to the end user.

One of the strengths of RBM is its full transparency on reporting the state of the message with regards to its delivery status, being read or not, a suggested action being clicked etc. All of these events are messaged back to the chatbot, which allows for detailed reaction to the user’s feedback. It enables also vast data analysis possibilities (unknown to SMS) that can be used to optimize campaigns e.g. by A/B testing different message options.

The P2A RBM Flow

To complete this overview, we also need to mention **P2A** in contrast to the so far discussed A2P direction. P2A is how the internet works: it is not the website that contacts you, it is the user to discover the right website and actively browse it. For example, a consumer may contact an RCS Customer Carebot by clicking a deep link on a brands website. Analysts like MobileSquared predict RBM traffic to follow suit and being dominated by P2A sessions.

For P2A to work, the chatbot needs to register itself in a way that allows it to be discovered. There are currently different approaches to the topic of chatbot discovery. Samsung’s RCS client offers a dedicated chatbot tab for browsing and searching chatbots. The MNO configures the RBM

directory service provider that handles the entries. The directory service may be the MNO's or one provided by a third-party.

Another way is to offer RCS P2A Deep Links, i.e. links on a website or 2D barcodes that seamlessly initiate an RCS chat session when clicked or scanned. These links trigger and leverage directly the RCS client on the end user phone, which not all clients support yet. Google believes in promoting Web URL-links to chatbots as part of e.g. their general search results or map service. Unlike Deep Links the URL-link method is requiring the MSISDN of the end user to be additionally determined and transmitted and the first RCS message sent is actually an A2P. Advantage is that URL-links can be deployed today as a pragmatic workaround to overcome constraints with RCS P2A Deep Links. Finally, there are other ways, like manually typing in the chatbot name or ID or using a SMS to initiate the RCS chat.

Regardless of the method, the technical key is for the user to find the chatbot ServiceID, which its RCS client can use to invite the chatbot onto a chat session. From then on, each message behaves as shown before on the A2P call flow.

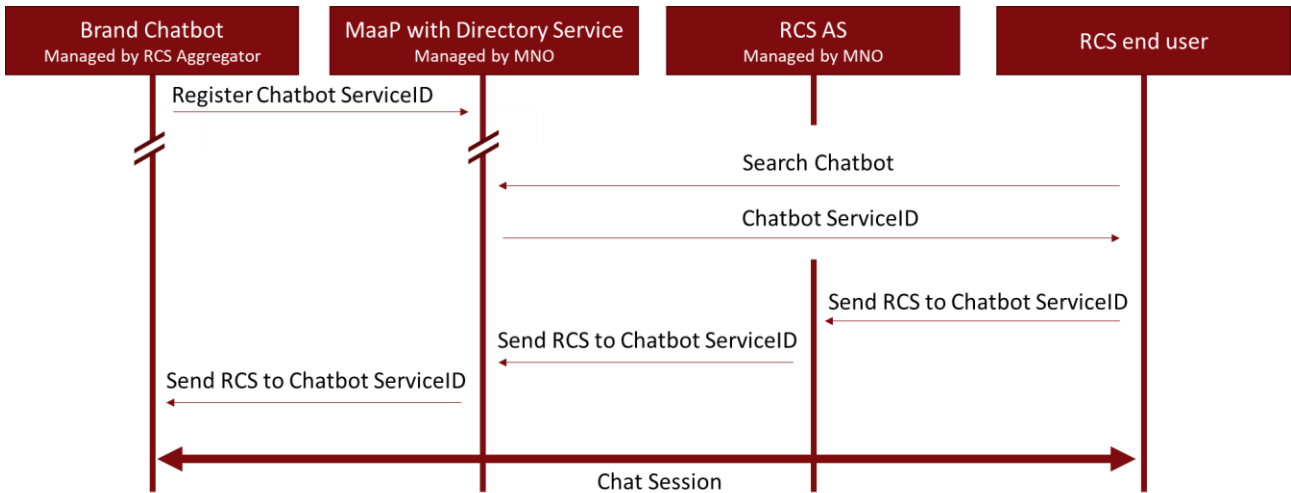

All these call flows simplistically read “MaaP, Managed by MNO”. The next chapter will show that there are actually several options for an MNO to deploy MaaP.

RBM Deployment Options

From on-premise to fully hosted

The **on premise** way for MNOs to deploy new services is to buy the necessary equipment and software, deploy them **on premise**, get personnel trained on operating them and offer them to the market.

Assuming a country with three MNOs, this would then look like the following figure: Each MNO has

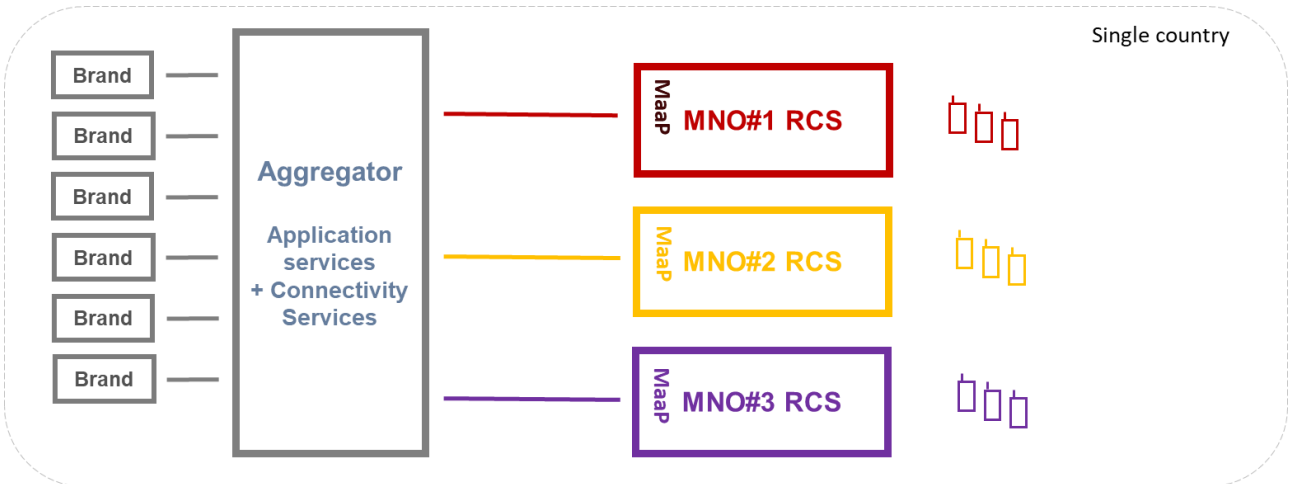

its own network enabled for RCS (via its IMS and an RCS AS, see previous chapter) and it runs its own MaaP instance, which offers interfaces to Aggregators. With this setup the RBM services are offered under the T&Cs of the MNO.

Alternative to self-managed on-premise solutions, the MNO has the choice of outsourcing RBM and P2P RCS in various degrees. In the next figure, MNO#2 has chosen a hosted solution for RCS and RBM, where a third-party is providing all these services in its data centers on behalf of MNO#2. Potentially, MNO#2 could select different third-parties for the RBM MaaP and the P2P RCS enabling. In any case, the services are still offered under the T&Cs of MNO#2

Finally, MNO#3 has opted to not enable its network with RCS, at least for now. In that case the MNO#3 subscribers could still be doing RCS if a third-party Cloud RCS solution is implemented in

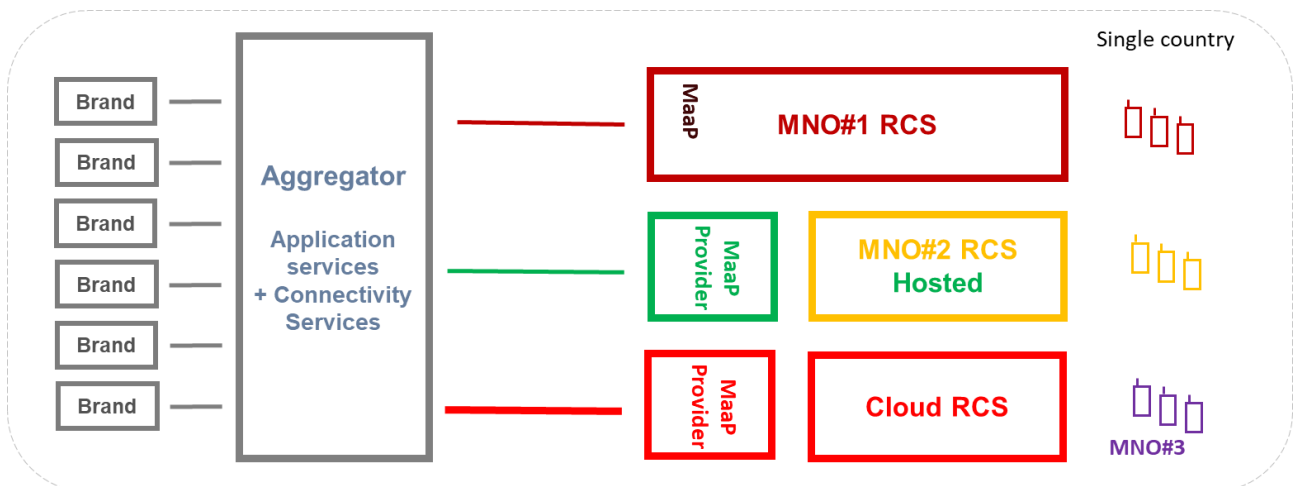



that country. In this case, the RCS and RBM services will be offered under the T&Cs of the Cloud RCS provider.

As for selecting the deployment model for MaaP, the MNO should also select the method(s) it wants to support for chatbot discovery as described in the previous P2A chapter.

Every MNO has its own story

In this chapter we'd like to go through real life experiences that MNOs across the world have on deploying their RBM service.

| | | |
|---|--|-----------------|
|  | MNO: | Vodafone |
| | Chosen MaaP Deployment: | On-Premise |
| | Source of MaaP: | Own development |
| Comments: | <p>Vodafone was the first MNO to launch RBM commercially in Europe. 15 Vodafone countries are live with RCS; five of them are running commercial RBM campaigns (with this number due to rise imminently). They opted for 'make' instead of 'buy', developing their own MaaP implementation from the ground up. Liz McCord, Principal Product Manager at Vodafone Group, explains that the company wanted to own its core RCS assets and ensure full end-to-end control and flexibility: "Holding the keys to the RCS platform allows us to provide the best user experience to our customers and maximize the commercial potential of the channel". In fact, Vodafone set up a fully centralized Group MaaP and IMS solution, so that every local operating company can easily launch RCS and RBM. A GSMA standard implementation means that just two key steps are needed to launch further markets: a simple domain registration configuration so that Vodafone users' messaging clients talk to the Vodafone RCS platform and to work closely with client providers like Samsung to make standard RCS software available on their devices. For Vodafone, the overarching objective of RCS Business Messaging today is to develop partner, brand and above all consumer trust in the service. Once this happens, RCS conversational campaigns will not only become widely available but will grow to become an invaluable part of mobile customers' lives.</p> | |
| Advice to other MNOs: | <p>"The time for RCS is now; the industry cannot wait any longer. Stay pragmatic whilst taking all necessary steps to drive businesses to embrace RCS as soon as possible."</p> | |

| | | |
|---|---|--|
|  | MNO: | Deutsche Telekom |
| | Chosen MaaP Deployment: | On-Premise for Germany and USA Hosted for other countries |
| | Source of MaaP: | Third-Parties |
| Comments: | <p>Looking at another major group, Deutsche Telekom, reveals that there is not a one size fits all solution. In Germany Deutsche Telekom has operated RCS since 2013, based on their own IMS. According to Martin Repp, RCS Product Manager at Deutsche Telekom, Deutsche Telekom is actively working on RBM, they expect to launch RBM in Germany soon. In most other European entities Deutsche Telekom is partnering with Google Jibe as their vendor to provide the hosted RCS service for its European networks.</p> | |
| Advice to other MNOs: | <p>Martin Repp's passionate advice to other MNOs is: "Launch! Don't let OTTs take the bread out of your mouth."</p> | |

| | | |
|---|--|----------------------------|
|  | MNO: | KDDI |
| | Chosen MaaP Deployment: | On-Premise |
| | Source of MaaP: | Third Party (WIT Software) |
| Comments: | <p>Confronted with the same challenge, namely the widely popular Japanese OTT service LINE, the three carriers NTT, KDDI and Softbank deployed their own RCS capabilities separately in their respective networks, but coordinated the launch of P2P RCS to happen on the same date in May 2018 and to use the same "+Message" branding with a unified user experience. This concerted effort made Japan the first "Gold Country", a GSMA terminology for countries with all tier1 MNOs supporting RCS. In May 2019 the three carriers launched RBM.</p> <p>In terms of MaaP implementation, all three deployed their own MaaP instance – however, they chose the identical solution offered by WIT Software and as such all offer the identical API, resulting in a unified and consistent experience for the enterprise brands and RCS aggregators. In</p> | |

| | |
|-----------------------|--|
| | <p>fact, according to Hideyuki Koto, Senior Manager for Messaging Strategy at KDDI, KDDI has a separate business unit that also serves as RCS aggregator and can offer RBM nationwide to brands.</p> <p>While business SMS is predominantly A2P, i.e. broadcasts or transactional messages from the enterprise brand to the users, the Japanese operators decided to focus their RBM initiative on P2A centric services. This differentiates the RBM channel from promotion heavy email or the in Japan widely deployed OTT service LINE. Additionally, RBM excels as a more secure channel considering that every end user has a verified personal identity assured when receiving the SIM card whereas email and LINE use separate non verified userIDs.</p> |
| Advice to other MNOs: | <p>“Start RCS, leverage the GSMA standards – it is the only choice for 5G messaging services. Proactiveness is key.” And Koto closes with referencing proudly the latest announcement of leveraging RCS for disaster recovery information like earthquake or tsunami warnings on top of the currently used SMS system.</p> |

| | | |
|---|---|--|
|  | MNO: | AT&T |
| | Chosen MaaP Deployment: | Hosted (on top of on-premise P2P RCS solution) |
| | Source of MaaP: | Third Party (Samsung) |
| Comments: | <p>Neil McGrath, the Lead Architect for MaaP at AT&T, pioneered the P2A centric vision that KDDI share, and helped to design the chatbot directory UI that is prominently featured on the Samsung messaging client. After launching with P2A, AT&T also introduced A2P campaigns with selected brands but the real highlight remains P2A and watching its impressive uptake: AT&T stats show an average of 10 visits per user, per month, to the chatbot directory, and while A2P campaigns showed an average of 1.25 messages per chat session, P2A sessions range between 5.4 messages per session for more text heavy use cases like news and up to 23 messages per session for chatbot assistants with complex text, images and interactivity.</p> <p>AT&T initially launched P2P RCS early on in 2015 based on a pre-universal profile standard, and decided early on for an on-premise deployment. However, for the RBM launch in March 2018, AT&T opted for a cloud hosted MaaP implementation, and Neil said that it took only seven months to deploy</p> | |

| | | |
|---|--|-------------------|
| | and test, and could have gone even faster - AT&T were also in the middle of launching Universal profile 1.0 at the same time as well. Now they are upgrading all the systems to full UP2.0 compliance, resulting in a state-of-the-art RCS network. | |
| Advice to other MNOs: | “Stop looking at messaging as texting, and start seeing it as social and business content sharing.” | |
|  | MNO: | China Mobile |
| | Chosen MaaP Deployment: | On-Premise |
| | Source of MaaP: | Third Party (ZTE) |
| Comments: | <p>The MNO with currently the highest numbers of monthly active RCS users is China Mobile with 86 million MAUs. China Mobile started with a trial in 2017 and launched P2P commercially in 2018. Given the huge size of the China Mobile network, scaling is a major concern. Hence, they opted for an on-premise deployment using a solution from ZTE. Their current P2P deployment is still based on an older RCS profile developed for China, but the plan is to upgrade to the very latest UP2.3 standard, predominantly driven by RBM – with a trial of that already underway. Jianping Zheng, Technology Manager, and Yue Liu, Senior Researcher at China Mobile, explained that only UP2.3 supports Standalone RBM messages, which removes the load from the central network components and therefore help China Mobile scaling its network better. While their MaaP is already supporting the new UP2.3 standard, their RBM trial is still limited by missing UP2.3 support from some handset clients. Both have been working on RCS for over 5 years and based on their experience they recommend focusing on leveraging the native RCS clients rather than working on custom RCS apps, even if it means waiting for the needed feature support.</p> <p>In China WeChat is extremely popular not only for messaging but also for payments. So, adding payment functionality to RBM will be another priority for China Mobile.</p> | |
| Advice to other MNOs: | Their advice to other MNOs is that “a healthy ecosystem is very important – from OEM to enterprises”. China Mobile therefore created a “5G Innovation Open Lab” where partners can join and test their products like new RCS chatbots. | |

| | | |
|---|--|--|
|  | MNO: | Telefónica |
| | Chosen MaaP Deployment: | Fully Hosted (incl. P2P RCS) |
| | Source of MaaP: | Third Parties (Google and Mavenir, depending on country) |
| Comments: | <p>Telefónica needed to find a solution for their different local networks, all having different starting points, e.g. with or without an IMS core. “After formal RFP evaluations we decided to recommend 2 hosted solutions, since it is cheaper and faster”, Tim Houlihan responsible for A2P Messaging Development EUROPE at Telefónica said. Telefónica Germany will go with Mavenir, whereas Telefonica Mexico is using Google – both for P2P RCS and RBM. According to Tim, key points to consider early in the process are reaching out to OEMs to get a plan in place for testing, as well as clarifying with the other MNOs in the country how the interconnections for P2P RCS and specifically for RBM are to be handled.</p> | |
| Advice to other MNOs: | <p>“Bring onboard the people responsible for business messaging: Think about the future, 160 characters won’t cut it. Embracing RCS should not be seen as a threat for the existing SMS revenues, RBM opens up options for addressing completely new business, like SMEs who cannot afford custom apps and moving over business that is done with apps today.”</p> | |

Summary

One common thread that comes up is ensuring you have a broad awareness of the RBM Ecosystem and steps needed to implement MAAP which this whitepaper has broadly covered.

RBM Platform Selection

When selecting your platform, the first decision is “make or buy?”. If you can **make** it, you have fullest control and flexibility as attested by Vodafone. It just might not be the fastest option.

So, if you opt for **buy**, you need to determine if you want to buy the software license and deploy it all on-premise into your own datacenter. That will give you maximum control but might involve some significant upfront investment for software and hardware. KDDI has for example chosen this path.

Alternatively, you can buy and decide to get the solution **hosted** by a third party in an external cloud or datacenter on behalf of your network. This should be the fastest route to RCS/RBM enable your network, at the cost of only partial control and some dependency towards the hosting partner. There is always an option to move to your own platform once the service is launched.

Commercially, hosted solutions typically come with a revenue share on RBM but less initial investment by Operators, whereas on-premise deployments are done typically with upfront software license fees and yearly software support fees.

The following [blog](#), produced by GSMA 'RCS goes Mainstream' provides a wider picture of the deployment options for RCS.

Wider RCS Ecosystem

Apart from selecting the appropriate platform solution, there are other aspects each MNO should consider and explore:

- Talk to your OEM phone vendors – agree support and testing procedures
- Talk to the other MNOs in your country – see if there is common interest like the example of Japan showed. Agree on how interconnections will be handled, GSMA's [MoU](#) is the document to get started there.
- Leverage the wide resources from GSMA on their [website](#)

About the Authors

About the GSMA

The GSMA represents the interests of mobile operators worldwide, uniting more than 750 operators with over 350 companies in the broader mobile ecosystem, including handset and device makers, software companies, equipment providers and internet companies, as well as organisations in adjacent industry sectors. The GSMA also produces the industry-leading MWC events held annually in Barcelona, Los Angeles and Shanghai, as well as the Mobile 360 Series of regional conferences.

For more information, please visit the GSMA corporate website at www.gsma.com.

Follow the GSMA on Twitter: @GSMA.

The GSMA RCS initiative brings together the mobile industry's leading operators, vendors and service providers to shape the RCS specification and implementation. Participating operators have the opportunity to work with software and handset developers, and product and technology experts, to shape the personal and business messaging future for the mobile industry.

For more information on the Future Networks Programme and its work on RCS, please visit www.gsma.com/futurenetworks/rcs/



Giovanni Benini, Partner at Global Telco Consult, a consultancy firm focused on all aspects of messaging.

For more information please visit the GTC website www.GlobalTelcoConsult.com.



GSMA HEAD OFFICE

Floor 2
The Walbrook Building
25 Walbrook
London
EC4N 8AF
United Kingdom
www.gsma.com